



ITALIAN KITCHEN TRADITIONAL C-SPOUT HOT WATER FAUCET

ROHL — Italian Kitchen Filtered Hot Water Dispensers

G1655LM

FEATURES

- Hot water faucet only
- Unique Anti-Scald lock: innovative push mechanism with exclusive spring-back valve
- Long lasting brass construction
- Swivel spout for ease of filling containers
- For use with U.1998 high performance hot water tank and U.1106 filter

COLORS/FINISHES

- Polished Chrome
- Polished Nickel
- Satin Nickel
- Matte Black*
- Italian Brass*
- Tuscan Brass**
- Unlacquered Brass**

WARRANTY

- 5-year Limited Warranty on Faucet
- *5-year Limited Warranty in Italian Brass and Matte Black
- ** No Warranty on Tuscan Brass and Unlacquered Brass

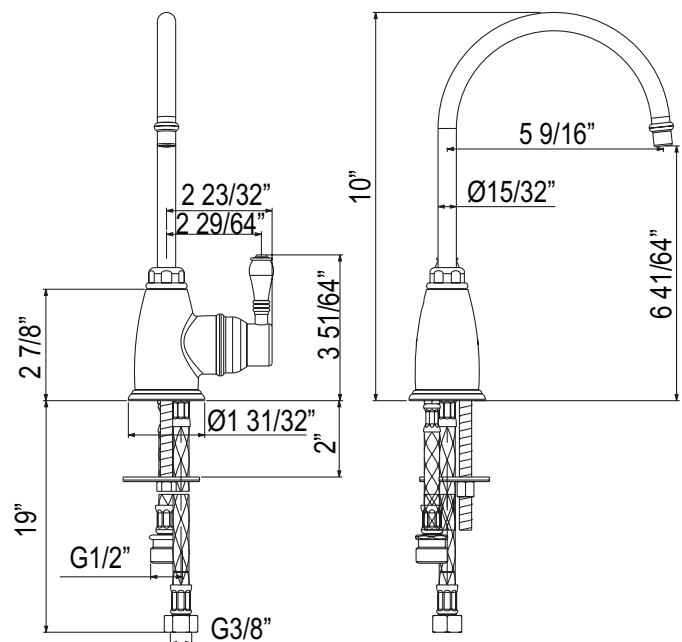

INSTALLATION INSTRUCTIONS

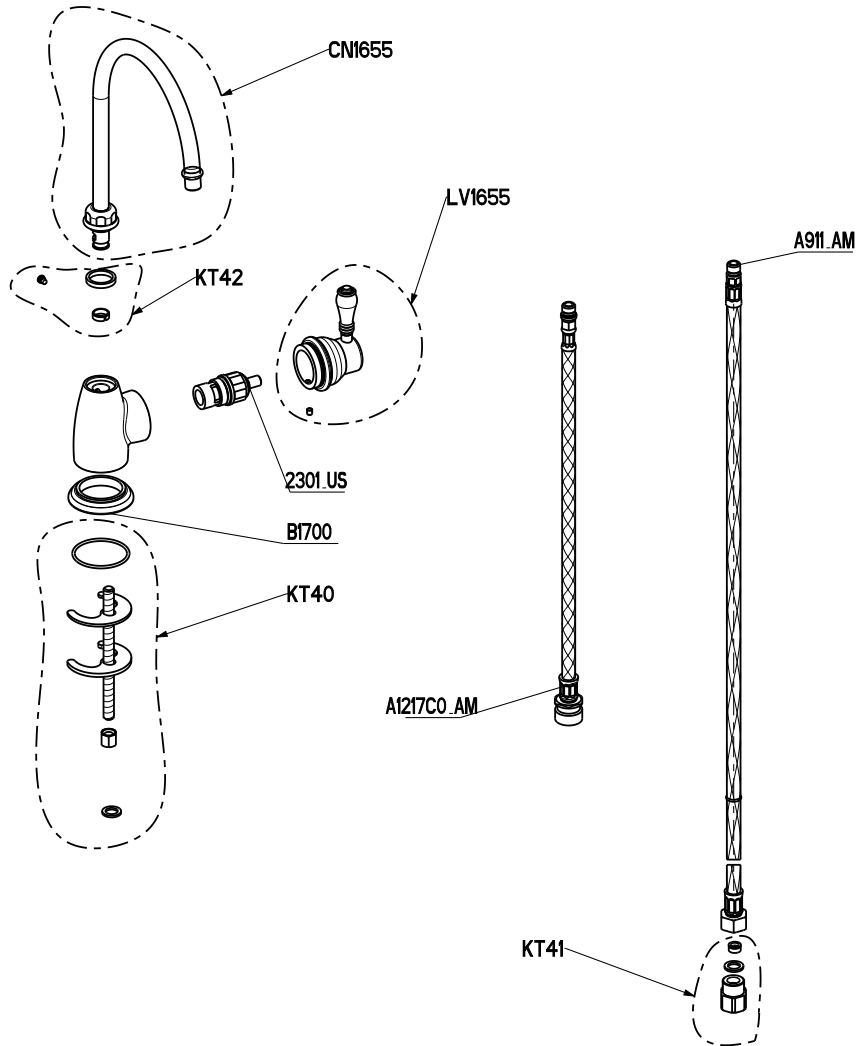

INSTALLATION INSTRUCTIONS

HOT WATER DISPENSER COLLECTION FOR USE ONLY WITH PERRIN AND ROWE HOT WATER TANK

G1445

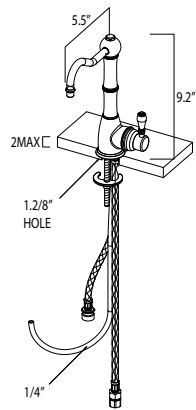

G1655

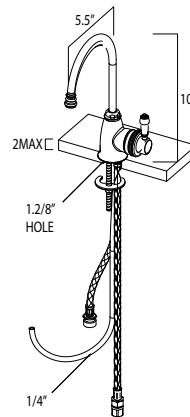

G7545

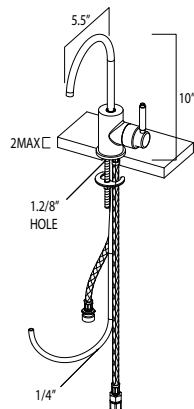

MB7945

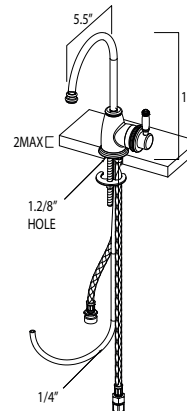

SCALDING HAZARD: The tap dispenses water up to 208.4°F (98°C), which can instantly cause scalds or burns. Use care when operating this appliance.

RECOMMENDED WORKING PRESSURE
Min 1.5bar / 22psi | Max 5bar / 75psi

INSTALLATION INSTRUCTIONS

The Hot Water Dispenser Collection

Installation & User Guide

Congratulations on the purchase of your **ROHL** product. Correctly installed and with sensible care, this product will give you many years of trouble free service.

IMPORTANT INFORMATION

Before you proceed... We recommend you engage the services of a registered plumber / builder to install this product.

Ensure you also read and understand the instruction manual that accompanies your Perrin and Rowe heater tank unit.

To avoid permanent damage to the heater tank it is important not to plug the unit until indicated in heater tank installation manual. Only operate the tank after it is filled with water.

In addition to the guide below it is essential that the written information is carefully read and understood.

Preparation Check Box for Installer

Flush the plumbing system before installing the kitchen product

Once unpacked, remove nut and clamping plate ready for installation.

1 Preparation:

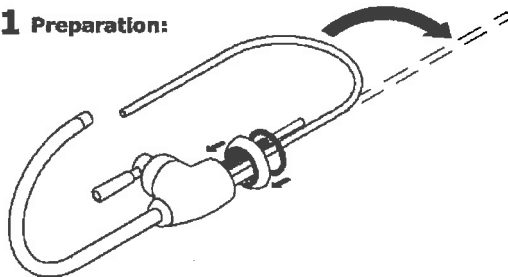

1. Unpack the hot water dispenser on a firm flat surface.
2. Carefully straighten the tubing from the bottom of the dispenser.
3. Ensure the base ring and the O seal are in place.

Attach silicone tube using the clip

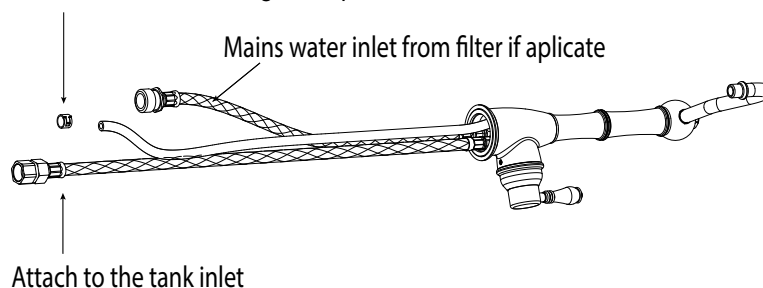

INSTALLATION INSTRUCTIONS

The Hot Water Dispenser Collection

Installation & User Guide

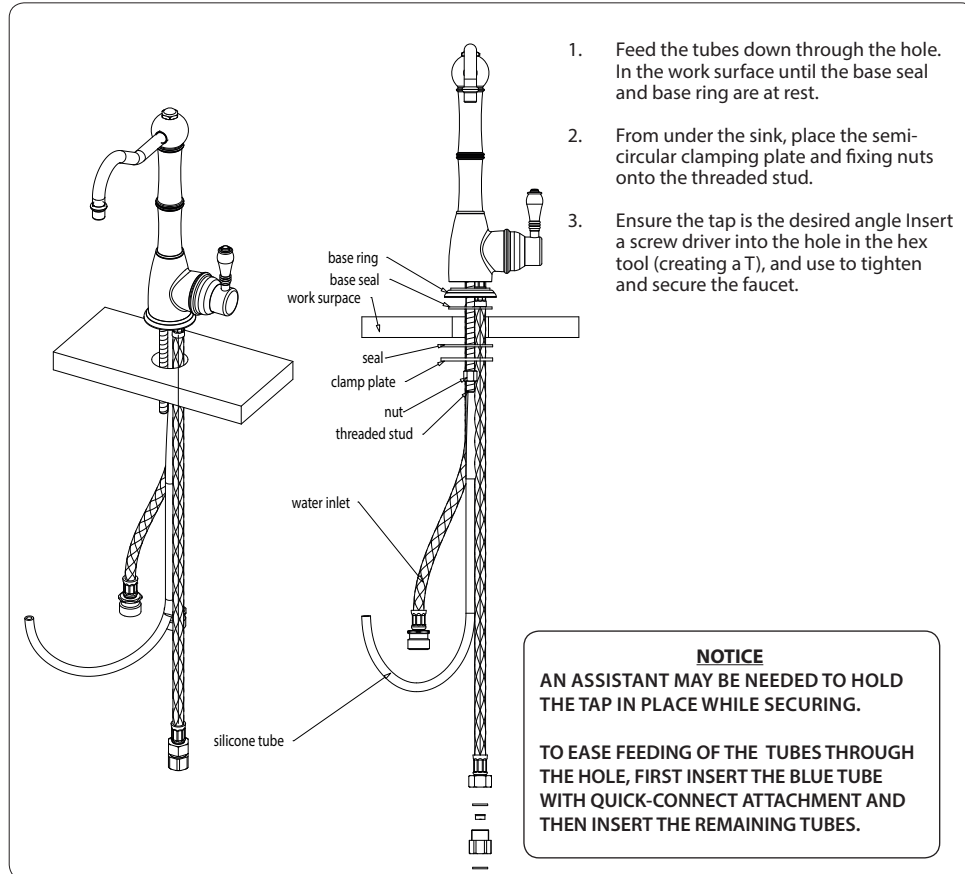

PLEASE ENSURE YOU HAVE READ & UNDERSTOOD THE PERRIN AND ROWE TANK GUIDE BEFORE USE.

BEFORE USE

- If further building work is to be carried out in the vicinity, cover the faucet to avoid damaging the finish.
- Please ensure that the installation complies with local plumbing codes.

CARE & MAINTENANCE

Wipe down after use to avoid water spotting and mineral build up.

Occasional cleaning with warm soapy water, followed by a polish with a soft cloth is all that is required to keep the plated finish in good condition.

Don't use abrasive liquids, powders, or pads to clean the shower. Don't use any products with ammonia, bleach, or limescale remover. You will damage the plated finish and void your guarantee.

ROHL

Authentic Luxury for Kitchen and Bath®

www.rohlhome.com

INSTALLATION INSTRUCTIONS

ROHL WARRANTY POLICY

Please contact the local retailer or showroom where you purchased this product for all warranty related claims.

ROHL

SPARE PARTS & SERVICE

3 Parker Irvine, California 92618-1605

Ph. 800 777 9762

Fax 714 557 8635

We would like to thank you for purchasing a **ROHL** product and take this opportunity to invite you to look at other luxury products.

Please contact us to receive our latest catalogue.

rohlinfo@rohlhome.com - www.rohlhome.com